

**Céliane™**  
**LCS² Cat. 6A RJ45 Socket**

Catalogue number(s): 673 46

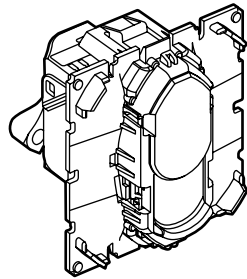

**CONTENTS**

Page

1. General characteristics . . . . .	1
2. Presentation . . . . .	1
3. Installation . . . . .	1
4. Technical characteristics . . . . .	1
5. Connection . . . . .	2
6. Overall dimensions . . . . .	2
7. Usual connection of RJ45 sockets . . . . .	2
8. Standards and approvals . . . . .	2
9. Performance . . . . .	3

**1. GENERAL CHARACTERISTICS**

RJ45 6A terminal socket for high speed computer connections to an IT network.  
Enables 10 Gbit/s transmission.  
Socket used with F/UTP or S/FTP cables.

	Designation	STP	Weight (g)
	Cat. 6A STP RJ45 Socket	673 46	29

**2. PRESENTATION**

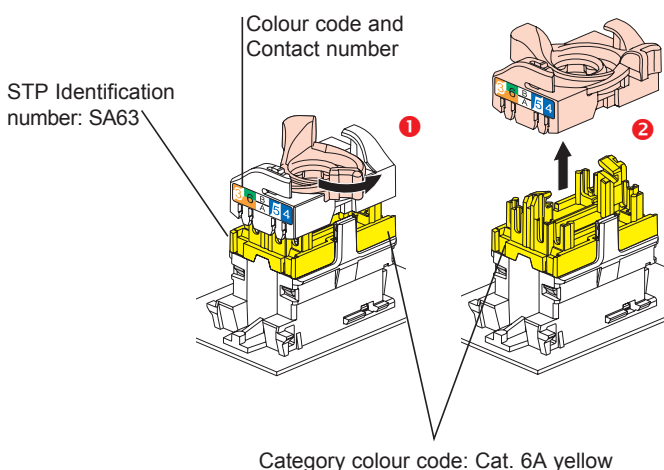

**3. INSTALLATION**

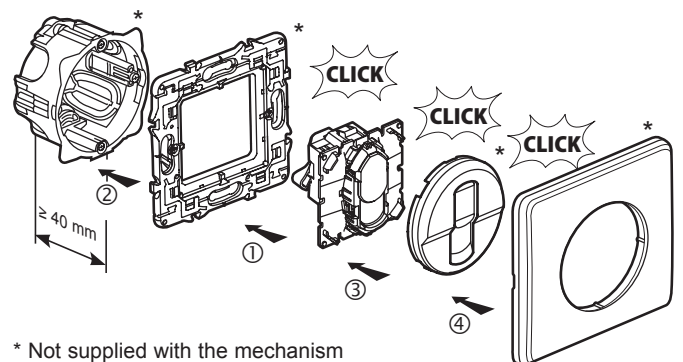

\* Not supplied with the mechanism

- 1 - Clip the mechanism onto the support frame from the front.
  - 2 - Screw the mechanism/support frame assembly to the flush-mounting box.
  - 3 - Clip the cover plate onto the mechanism.
  - 4 - Clip the plate onto the support frame.
- Can be fitted with all Céliane finishes.  
Multi-gang horizontal and vertical mounting.  
Can be double-mounted after breaking off fins.

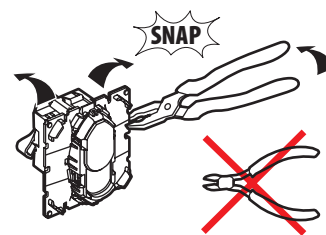

**4. TECHNICAL CHARACTERISTICS**

**4.1 Material characteristics**

Contacts: gold/nickel, thickness of gold > 0.8 µm min.

Metal parts: bronze, nickel, platinum, gold

PBT polycarbonate

For STP products the body and the separator are made of metal alloy with a copper/nickel coating.

**4.2 Electrical characteristics**

Breakdown voltage ≥ 1000 V.

Contact resistance ≤ 20 mΩ.

Insulation resistance ≥ 500 MΩ at 100 V DC.

Connector tested and guaranteed to support POE signals, standard IEEE 802.3af and POE+, draft standards 802.3at, up to 2500 connections and disconnections with load.

Tests are carried out with 2 simultaneous POE+ circuits producing a minimum total power of 50W.

**4. TECHNICAL CHARACTERISTICS (cont.)**

**4.3 Mechanical characteristics**

Max. number of connections and disconnections: 5 without refreshing the cable

Endurance: 2500 movements (plug insertion/withdrawal)  
 IK03

**4.4 Climatic characteristics**

Operating temperature: - 40°C to + 70°C  
 Humid heat cycle 21 days

**5. CONNECTION**

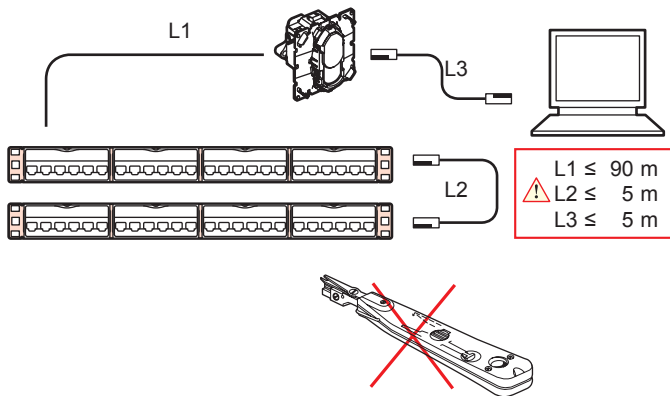

**6. OVERALL DIMENSIONS**

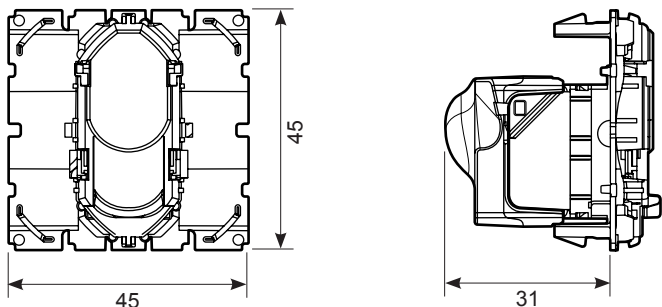

**7. USUAL CONNECTION OF RJ45 SOCKETS**

Accepts following cable connectors:

RJ11 (4 contacts), RJ12 (6 contacts), RJ45 (9 contacts).

Double colour code EIA – TIA 568 A and B on terminals:

- STP 9 contacts with 360° shield

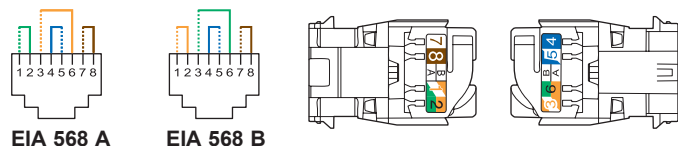

Conductors supported:

- Single-strand: 0.5 to 0.65 mm, AWG 22 to 25

- Multi-strand: AWG 26

- Polyethylene conductor insulation: max. Ø with insulation 1.58 mm

**7. USUAL CONNECTION OF RJ45 SOCKETS (cont.)**

The RJ45 connectors are equipped with a rotating locking system that does not require special tools and enables rewiring in the event of error.

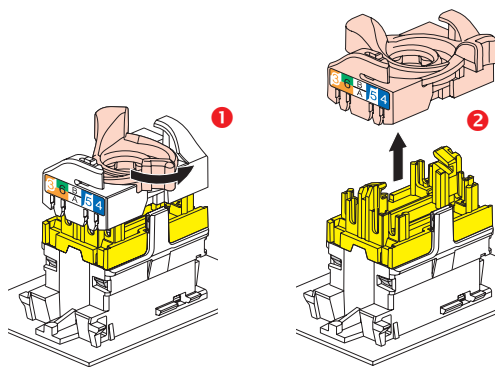

This system allows the wire pairs to be spread easily before attaching them to the connector.

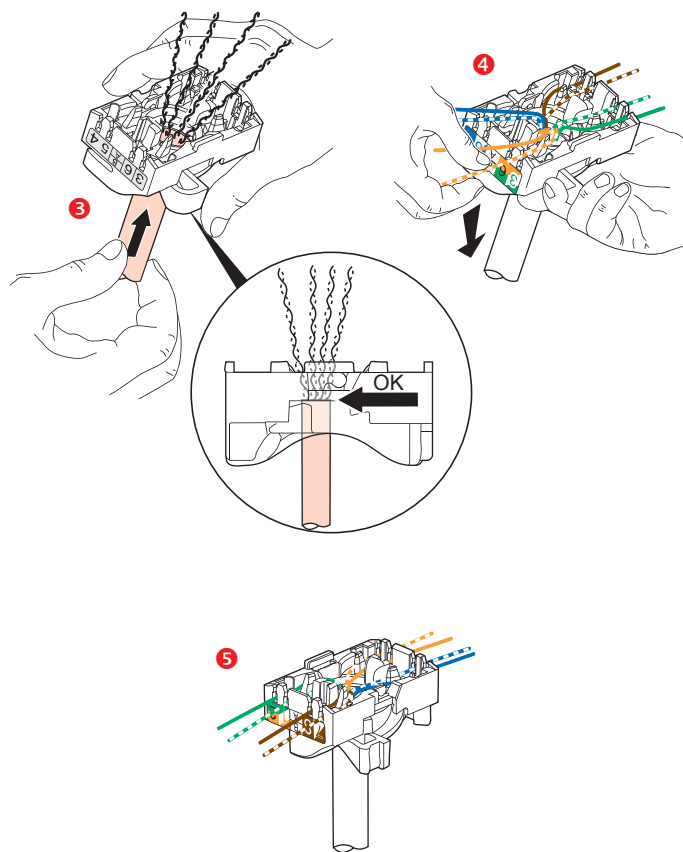

Spreading the wires ensure that pairs are separated by the required 13 mm.

Spreading the pairs at 90° in relation to the cable ensures the best performance levels.

**8. STANDARDS AND APPROVALS**

Conforms to standards: ISO 11801 Second edition

EN 50173 Second edition

EIA/TIA-568-B.2

NFC 20730

Standard 8877-603.7

**9. PERFORMANCE**

**9.1 Permanent link performance with F/UTP cable**  
 Return loss

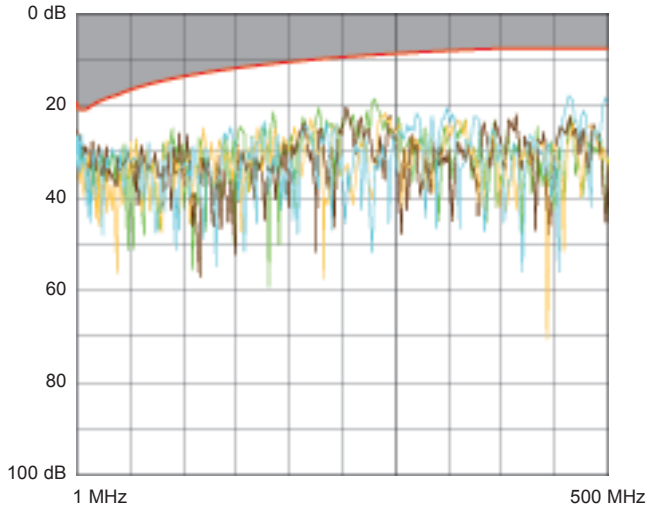

Attenuation

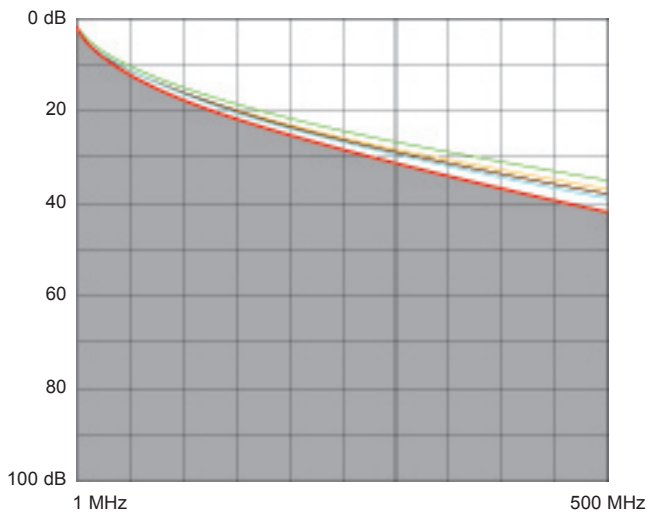

NEXT (Near end Crosstalk Attenuation)

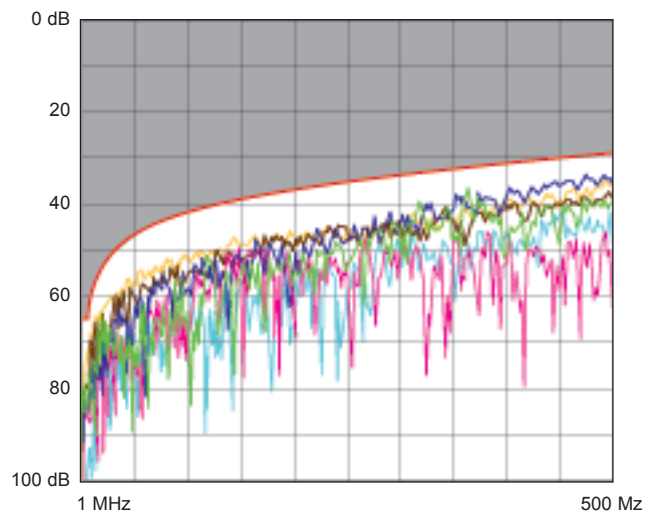

**9. PERFORMANCE (cont.)**

**9.1 Permanent link performance with F/UTP cable (cont.)**  
 PS NEXT (Power Sum NEXT)

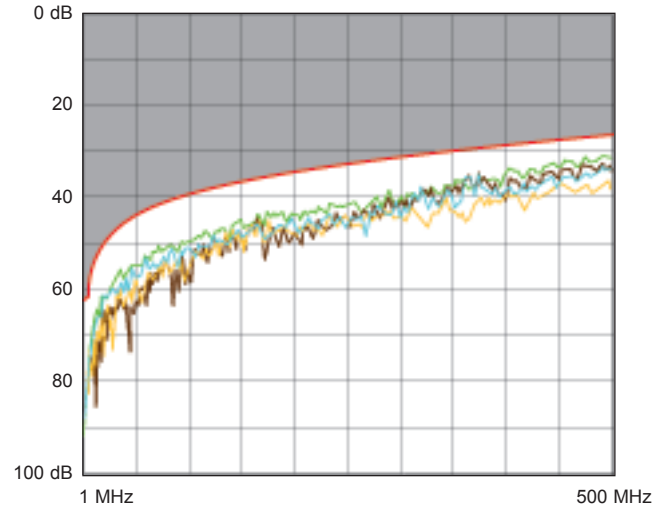

ACR (Attenuation to Crosstalk Ratio)

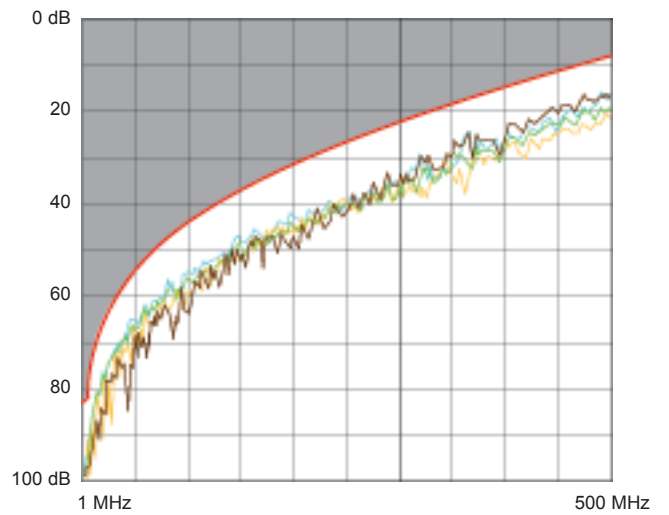

ELFEXT (Equal Level End Crosstalk Attenuation)

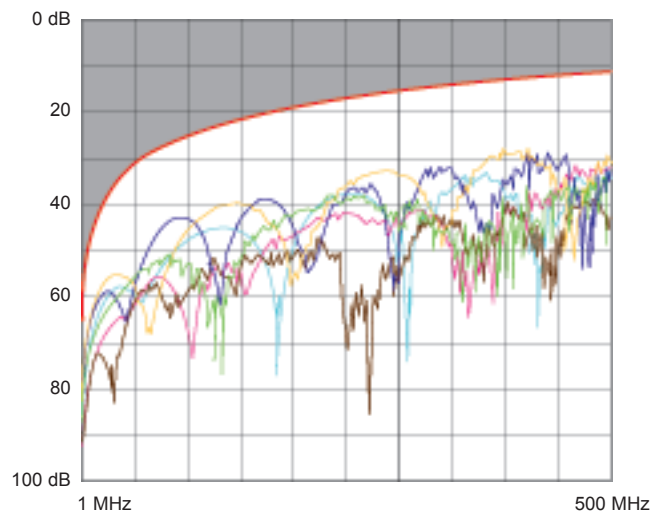

9. PERFORMANCE (cont.)

9.1 Permanent link performance with F/UTP cable (cont.)

Delay skew

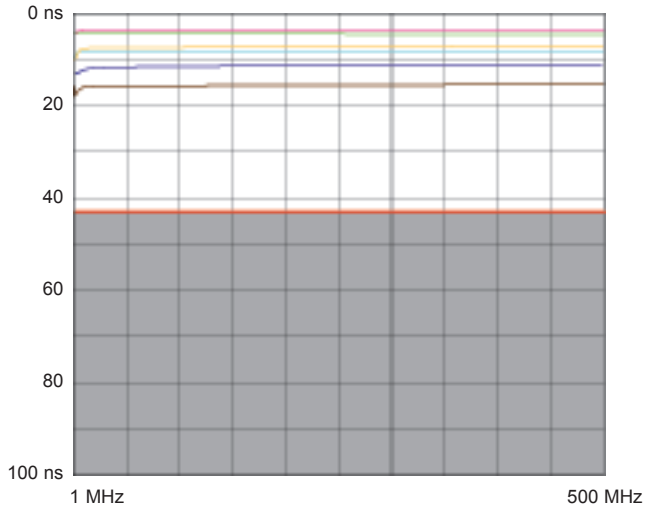

9.2 Permanent link performance with S/FTP cable

Return loss

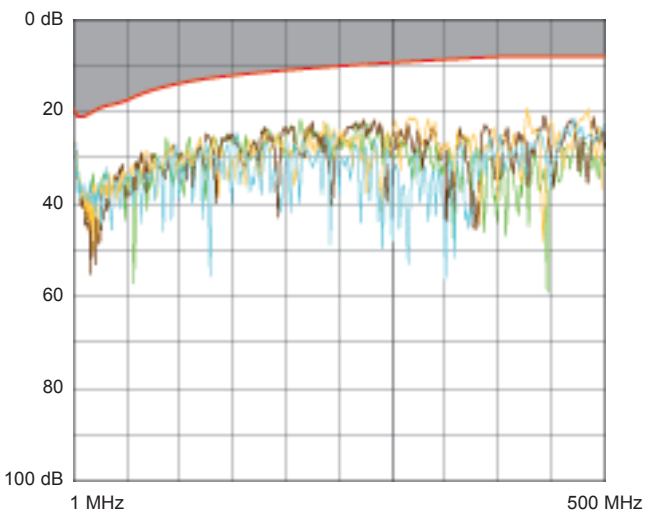

Attenuation

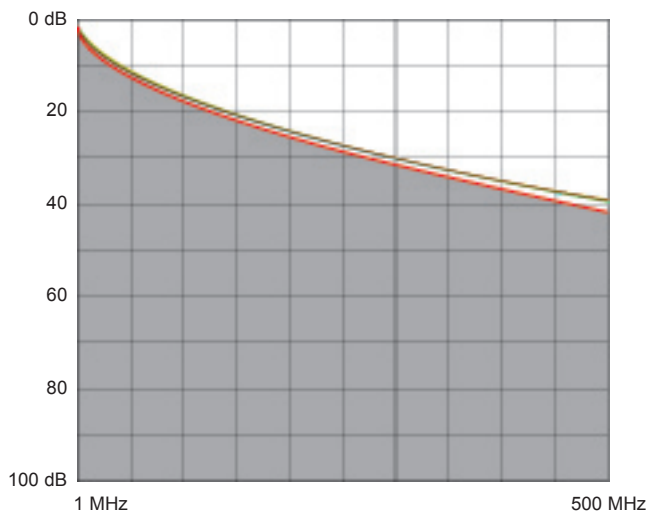

9. PERFORMANCE (cont.)

9.2 Permanent link performance with S/FTP cable (cont.)

NEXT (Near end Crosstalk Attenuation)

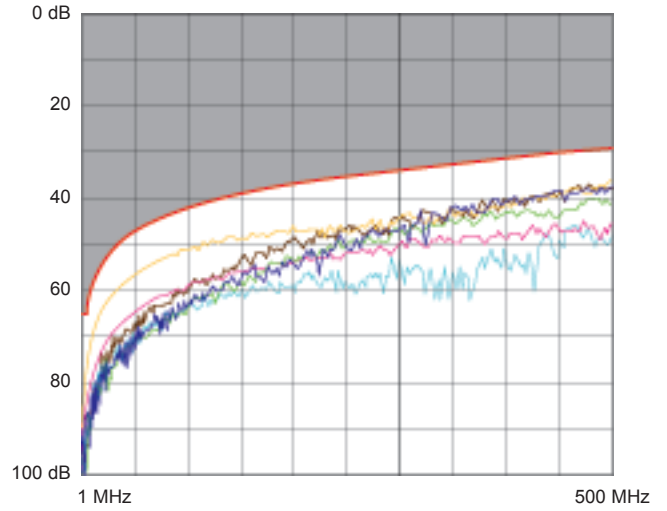

PS NEXT (Power Sum NEXT)

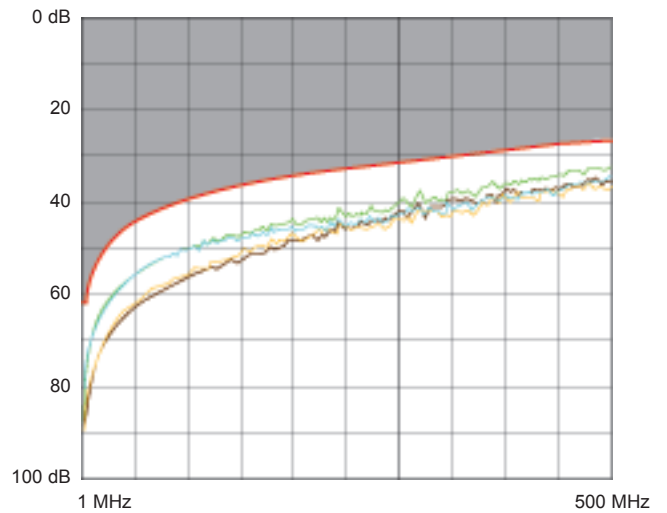

ACR (Attenuation to Crosstalk Ratio)

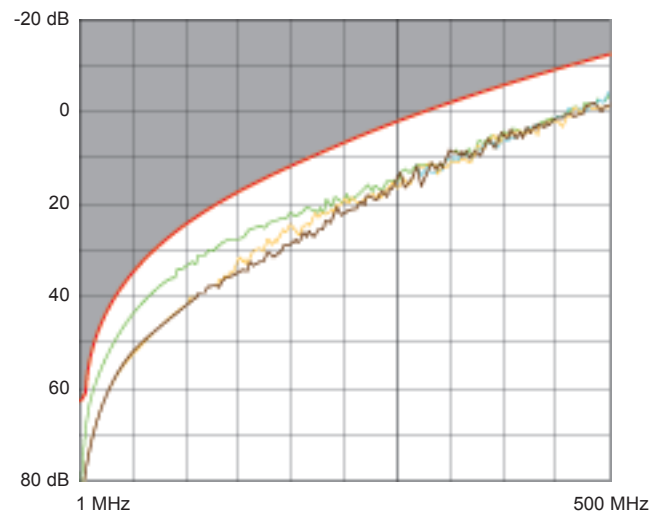

9. PERFORMANCE (cont.)

9.2 Permanent link performance with S/FTP cable (cont.)  
ELFEXT (Equal Level End Crosstalk Attenuation)

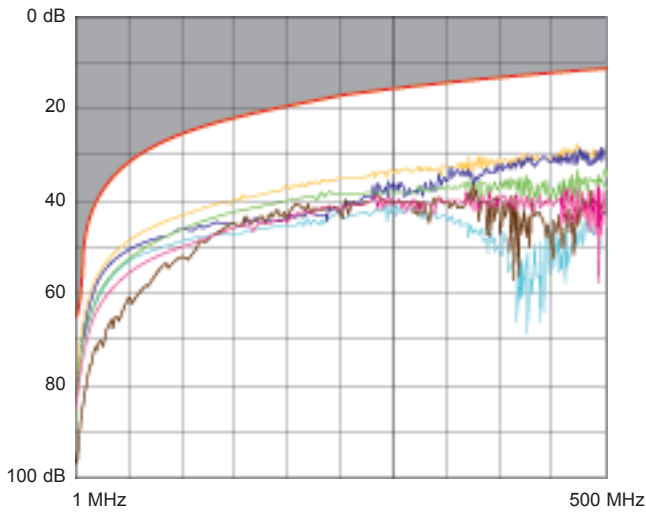

Delay skew

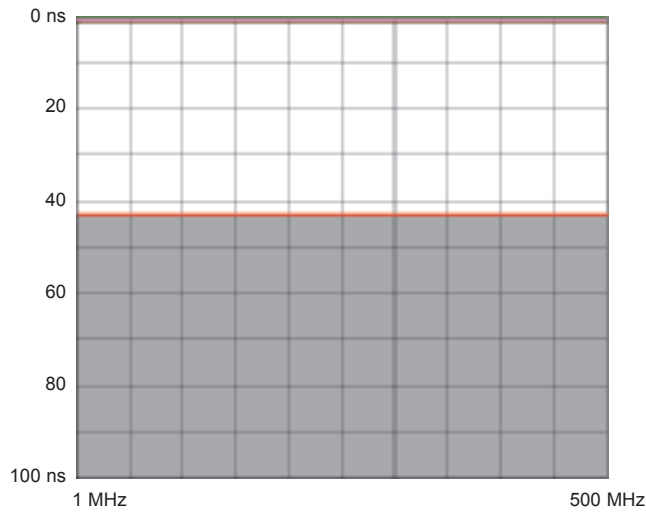

9.3 Channel performance

Return loss

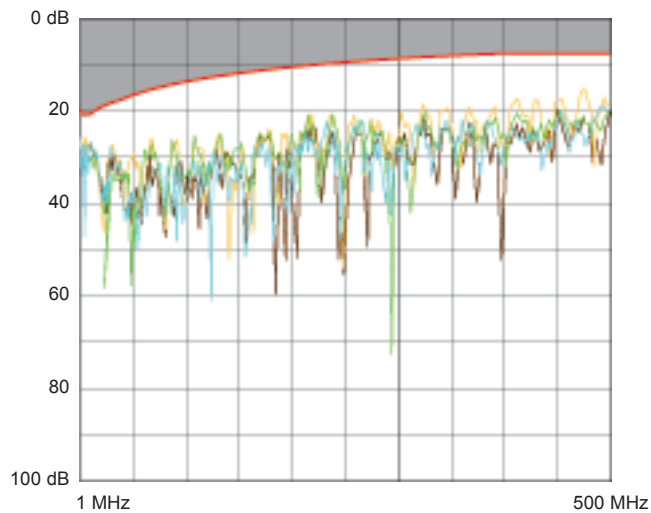

9. PERFORMANCE (cont.)

9.3 Channel performance (cont.)  
Attenuation

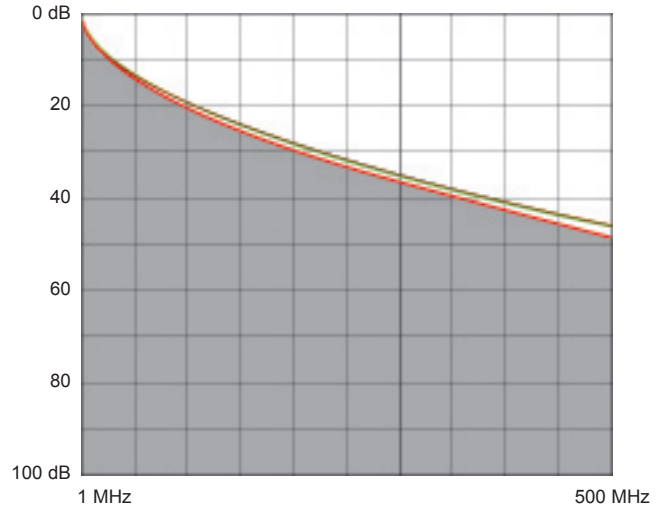

NEXT (Near end Crosstalk Attenuation)

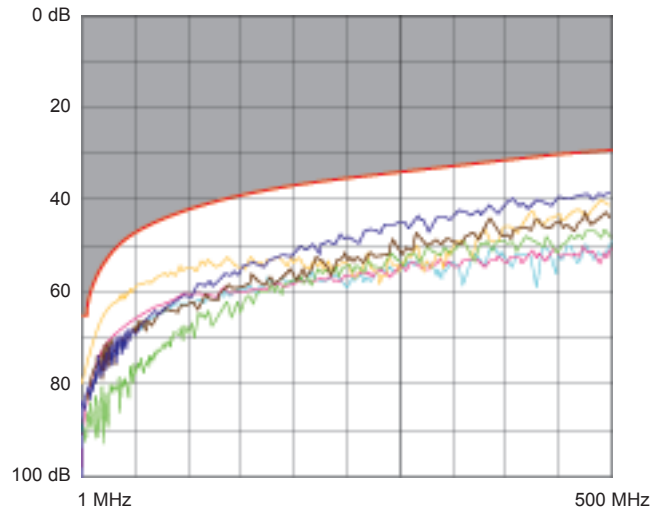

PS NEXT (Power Sum NEXT)

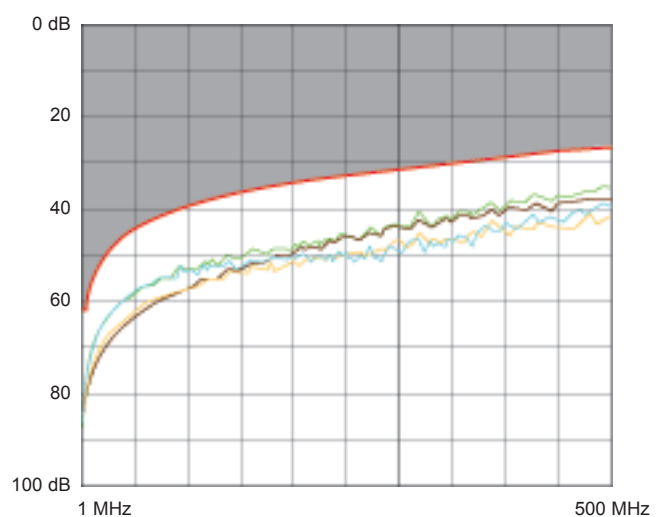

9. PERFORMANCE (cont.)

9.3 Channel performance (cont.)

ACR (Attenuation to Crosstalk Ratio)

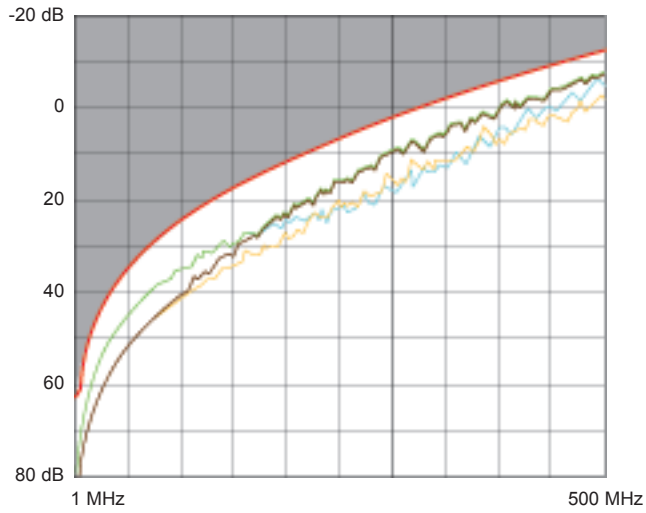

ELFEXT (Equal Level End Crosstalk Attenuation)

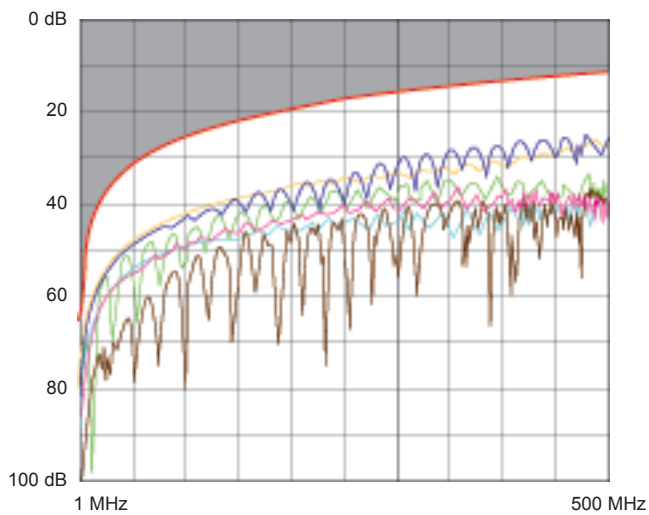

Delay skew

